



N-channel 600V, TO-92 MOSFET N-溝道場效應管

■ Features 特點

Low on-resistance 低導通電阻

Super high density cell design 超高元胞密度設計

Fast Switching Characteristics 快速開關特性

■ Internal Schematic Diagram 內部結構

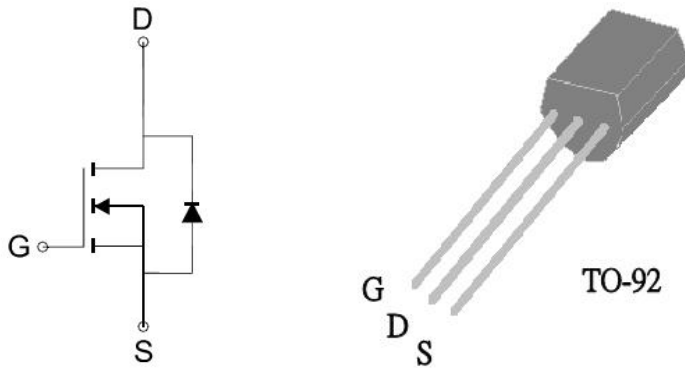

■ Absolute Maximum Ratings 最大額定值

Characteristic 特性參數	Symbol 符號	Rat 額定值	Unit 單位
Drain-Source Voltage 漏極-源極電壓	$BV_{DSS}$	600	V
Gate- Source Voltage 柵極-源極電壓	$V_{GS}$	$\pm 30$	V
Drain Current (continuous)漏極電流-連續	$I_D$ (at $TC = 125^\circ C$ )	400	mA
Drain Current (pulsed)漏極電流-脈沖	$I_{DM}$	3	A
Total Device Dissipation 總耗散功率	$P_{TOT}$ (at $TC = 25^\circ C$ )	2	W
Thermal Resistance Junction-Ambient 熱阻	$R_{\theta JA}$	150	$^\circ C/W$
Junction/Storage Temperature 結溫/儲存溫度	$T_J, T_{stg}$	-55~150	$^\circ C$



■ Electrical Characteristics 電特性

( $T_A=25^{\circ}\text{C}$  unless otherwise noted 如無特殊說明，溫度為  $25^{\circ}\text{C}$ )

Characteristic 特性參數	Symbol 符號	Min 最小值	Typ 典型值	Max 最大值	Unit 單位
Drain-Source Breakdown Voltage 漏極-源極擊穿電壓( $I_D=1\text{mA}, V_{GS}=0\text{V}$ )	$BV_{DSS}$	600	—	—	V
Gate Threshold Voltage 柵極開啓電壓( $I_D=250\mu\text{A}, V_{GS}=V_{DS}$ )	$V_{GS(th)}$	2	—	4	V
Zero Gate Voltage Drain Current 零柵壓漏極電流( $V_{GS}=0\text{V}, V_{DS}=600\text{V}$ )	$I_{DSS}$	—	—	100	$\mu\text{A}$
Gate Body Leakage 柵極漏電流( $V_{GS}=\pm 30\text{V}, V_{DS}=0\text{V}$ )	$I_{GSS}$	—	—	$\pm 1$	$\mu\text{A}$
Static Drain-Source On-State Resistance 靜態漏源導通電阻( $I_D=400\text{mA}, V_{GS}=10\text{V}$ )	$R_{DS(on)}$	—	—	9	$\Omega$
Input Capacitance 輸入電容 ( $V_{GS}=0\text{V}, V_{DS}=10\text{V}, f=1\text{MHz}$ )	$C_{ISS}$	—	375	—	pF
Common Source Output Capacitance 共源輸出電容( $V_{GS}=0\text{V}, V_{DS}=10\text{V}, f=1\text{MHz}$ )	$C_{OSS}$	—	170	—	pF
Reverse Transfer Capacitance 反向傳輸電容 ( $V_{GS}=0\text{V}, V_{DS}=10\text{V}, f=1\text{MHz}$ )	$C_{RSS}$	—	45	—	pF
Gate Source Charge 柵源電荷密度 ( $V_{DS}=480\text{V}, I_D=2\text{A}, V_{GS}=10\text{V}$ )	$Q_{gs}$	—	2	—	nC
Gate Drain Charge 柵漏電荷密度 ( $V_{DS}=480\text{V}, I_D=2\text{A}, V_{GS}=10\text{V}$ )	$Q_{gd}$	—	5.5	—	nC
Turn-On Delay Time 開啓延遲時間 ( $V_{DS}=200\text{V}, I_D=1\text{A}, R_{GEN}=50\Omega, V_{GS}=10\text{V}$ )	$t_{d(on)}$	—	10	—	ns
Turn-On Rise Time 開啓上升時間 ( $V_{DS}=200\text{V}, I_D=1\text{A}, R_{GEN}=50\Omega, V_{GS}=10\text{V}$ )	$t_r$	—	12	—	ns
Turn-Off Delay Time 關斷延遲時間 ( $V_{DS}=200\text{V}, I_D=1\text{A}, R_{GEN}=50\Omega, V_{GS}=10\text{V}$ )	$t_{d(off)}$	—	52	—	ns
Turn-On Fall Time 開啓下降時間 ( $V_{DS}=200\text{V}, I_D=1\text{A}, R_{GEN}=50\Omega, V_{GS}=10\text{V}$ )	$t_f$	—	19	—	ns

■ TYPICAL CHARACTERISTIC CURVE 典型特性曲线

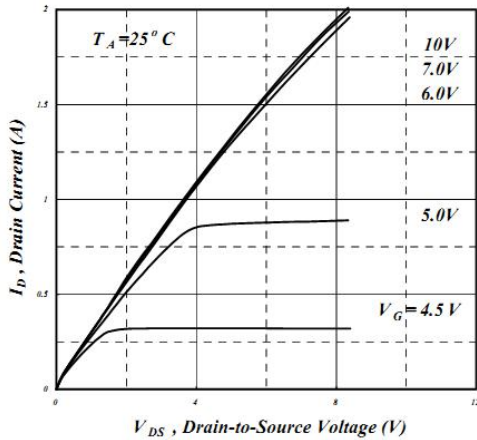

Figure 1. Output Characteristics

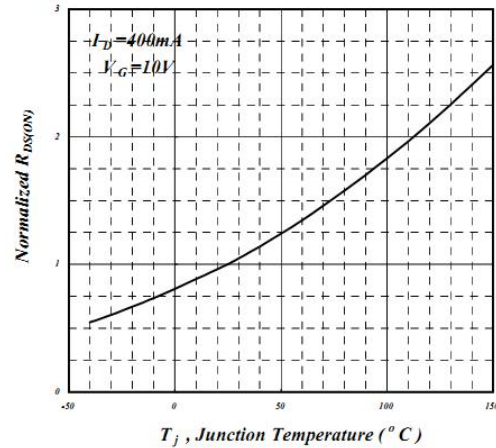

Figure 2. On-Resistance Variation with Temperature

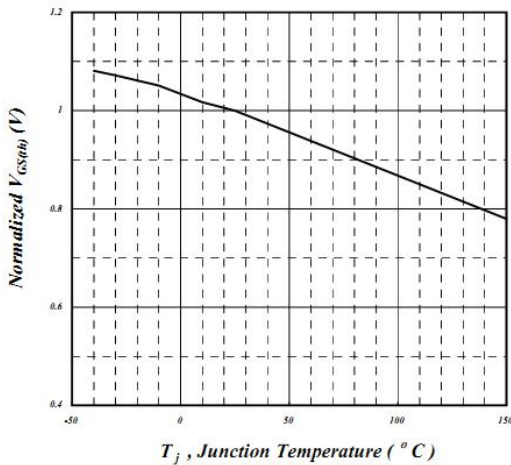

Figure 3. Gate Threshold Variation with Temperatures

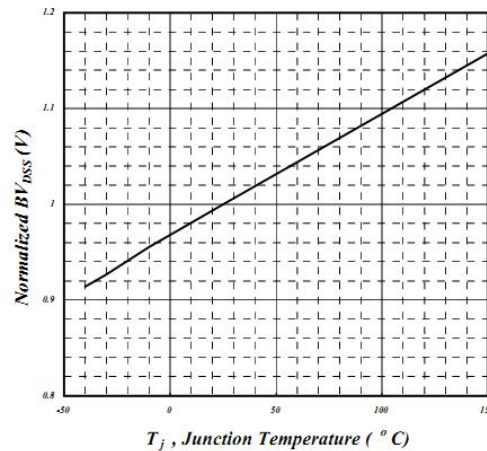

Figure 4. Breakdown Voltage Variation with temperatures

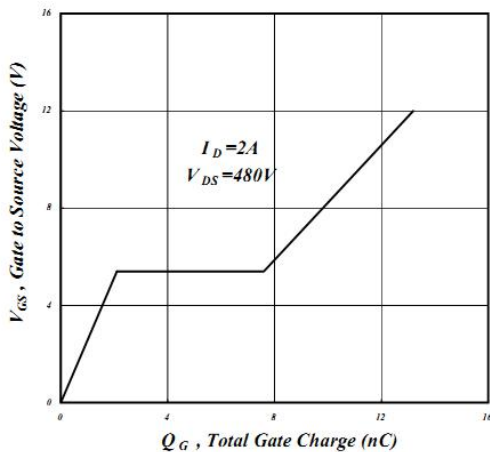

Figure 5. Gate charge VS. Gate-source Voltage

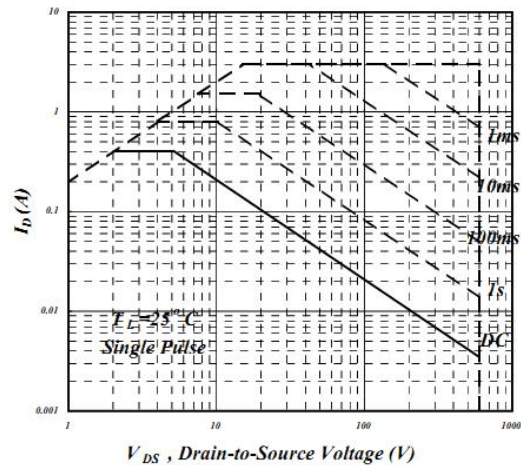
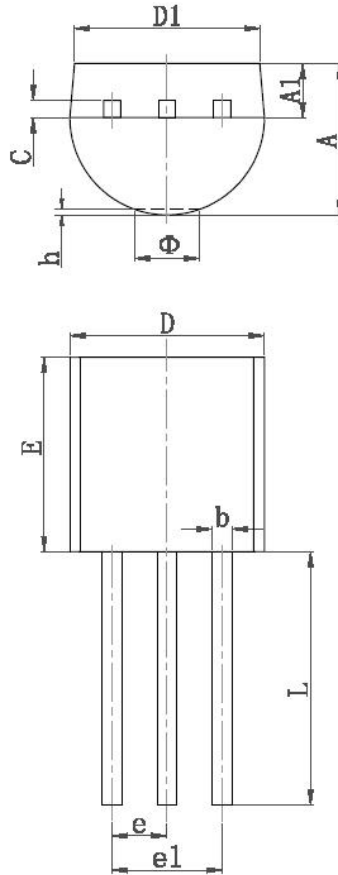

Figure 6. Maximum Safe Operating Area



■TO-92 外形封裝尺寸(DIMENSION)



Symbol	Dimensions In Millimeters		Dimensions In Inches	
	Min	Max	Min	Max
A	3.300	3.700	0.130	0.146
A1	1.100	1.400	0.043	0.055
b	0.380	0.550	0.015	0.022
c	0.360	0.510	0.014	0.020
D	4.400	4.700	0.173	0.185
D1	3.430		0.135	
E	4.300	4.700	0.169	0.185
e	1.270TYPE		0.050TYPE	
e1	2.440	2.640	0.096	0.104
L	14.100	14.500	0.555	0.571
Φ		1.600		0.063
h	0.000	0.380	0.000	0.015